

Spa mist II



Hair Care Is the Root of All Beauty

Sleek, supple hair that reflects ideas of the stylist in every detail.
Hairstyles that customers hold in admiration.

That kind of beauty only comes with healthy hair, when each
strand is soft and supple to the tip.

Spa Mist II uses a soft, microscopic mist that penetrates
the scalp and hair—and the customer's soul.

Used with treatments like the Head Spa for giving clients
all-round, feel-good hair care, or with hair coloring or a perm,
Spa Mist II helps you care for hair so clients leave
looking and feeling beautiful.

Spa mist II

Control the Temperature and Quantity of Mist — Helping You Provide the Best Head Spa and Treatment Experience

Spa Mist II was developed with a focus on using the power of mist with its tremendous potential. An ultrasonic transducer vibrating at 1.6 million times a second generates a fine mist of microscopic water particles.

The temperature and quantity of the mist can be freely controlled and used for relaxation treatments like the Head Spa, as well as acid hair coloring and perms.

Hair is set gently and with great care.

Spa Mist II is highly functional yet compact. And its sleek cubic design is well matched with the décors of high-end salon spaces.



Uniform heating for a consistent finish

Mist fills the cap, infusing the hair with moisture and uniform warmth. Surrounded by a gentle mist, every strand of hair is naturally infused with the cosmetic ingredients for a consistent finish.



Cooling sustains the treatment

The cooling function locks the treatment particles and acid hair color into the hair. The mist heating and cooling functions combine to give longer-lasting results.



Relaxation

Open Mist provides a gentle heating for comfort, along with an aroma for a soothing, high-class experience. It's relaxation taken to a new level.

Function & Performance Open Mist and a mist cap turn ordinary treatment into care treatment.

OPEN MIST

Warmth creates comfort

- Allows staff to more easily give customers a comfortable shampoo and scalp treatment.
- The mist and warmth combine to relax the client.



SCALP CARE

Open the pores to clean scalp

- Through moisturizing and heating, pores open to free up keratotic plugs and debris.
- With minimal burden on the scalp, debris and keratotic plugs are removed for beautiful scalp.



HAIR CARE

Penetrates deep into hair for longer-lasting effect

- Opens the cuticle layers so that treatment particles can go deep into the hair.
- Cooling closes the cuticles to keep hair healthy.



COLOR

Even coloring, minimal fading

- The microscopic mist is sent into the cap, where it circulates surrounding every hair strand with heat and ensuring an even finish.
- Cooling fixates the acid hair color into the hair for longer-lasting results.



PERM

Beautiful ridges in a short time

- Uniform heating gently promotes the softening process throughout the hair.
- Creates beautiful ridges in minimal time.



HAND CARE

Moist, soft hands

- Heated mist enhances the cleansing and moisturizing of hands.
- Brings added value to hand care services.

Hair temperature change (during shampoo)

Without Open Mist



- Hair gradually cools, resulting in not only less lather but also cold lather.
- The client feels cold.

With Open Mist



- More shampoo lather is generated and the stylist's hands slide easily.
- The client gets a warm, comfortable feeling right to behind the ears.

State of pores and scalp

Before treatment



Hardened sebum clogs the pores.

Mist heating



Moisture spreads throughout the scalp, opening the pores and turning the sebum into a liquid.

8 minutes of heating, 48°C

After shampoo



Debris is removed, and the pores are open and clean.

Level of penetration and durability

Data 1, 2, and 3 are based on tests in which the dyeing capacity and level of penetration on a hair bundle are assessed using acid dye on human grey hairs.

Data (1): Surface comparison (after applying dye)

With mist treatment
Heating: 15 min.
Cooling: 5 min.

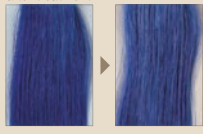

Immediately after treatment



After 7 shampoos

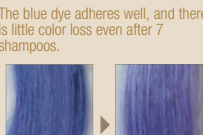

The blue dye adheres well, and there is little color loss even after 7 shampoos.

Data (2): Cross section comparison (after applying dye)

With mist treatment
Heating: 15 min.
Cooling: 5 min.

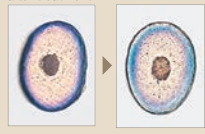

Immediately after treatment

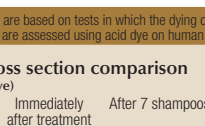

After 7 shampoos

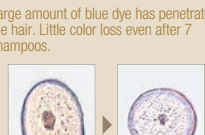

Large amount of blue dye has penetrated the hair. Little color loss even after 7 shampoos.

Data (3): Comparison of dyeing capacity and lasting strength

The hair bundle in Data 1 was measured with a spectrophotometer and a graph was made using the K/S value, which is an equivalent of the dye concentration value (absorbance value).

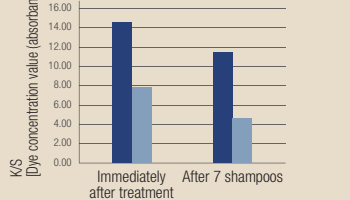

■ With mist treatment Heating: 15 min. Cooling: 5 min. ■ Without mist treatment 15 min.

Measuring the dye concentration by absorption of light, when compared to a hair bundle in which the dye sets naturally, a mist-treated hair bundle has higher dyeing capacity and greater durability just after treatment and even after seven shampoos.

Perm wave strength (when applying perm lotion)

Data 4 and 5 are based on tests in which a 17-mm-diameter rod and perm lotion were used to wind black human hair (damage level 3).

Data (4): Comparison of wave strength (after applying perm lotion)

With mist treatment



After heating 5 minutes

After heating 10 minutes



The hair bundle heated with mist for 5 minutes had more wave strength and more defined curls than the hair bundle that underwent natural setting for 10 minutes.

Data (5): Comparison of wave strength

Graph showing the SP efficiency of waves formed on the hair bundle in Data 4.



■ With mist treatment ● Without mist treatment

Original Services

Combine treatment categories to offer a wider range of services.

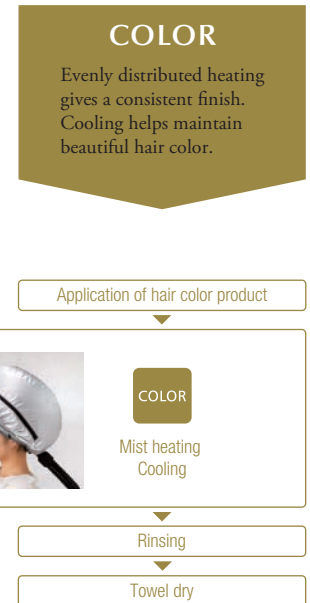
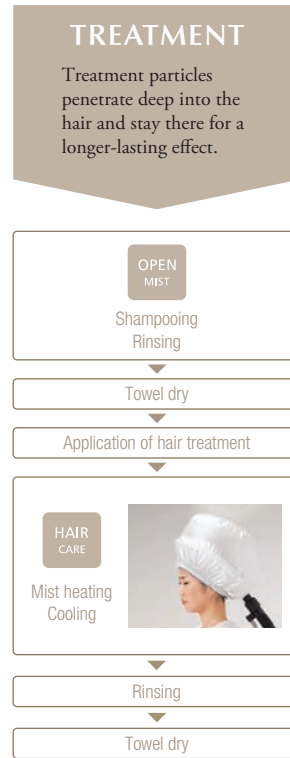
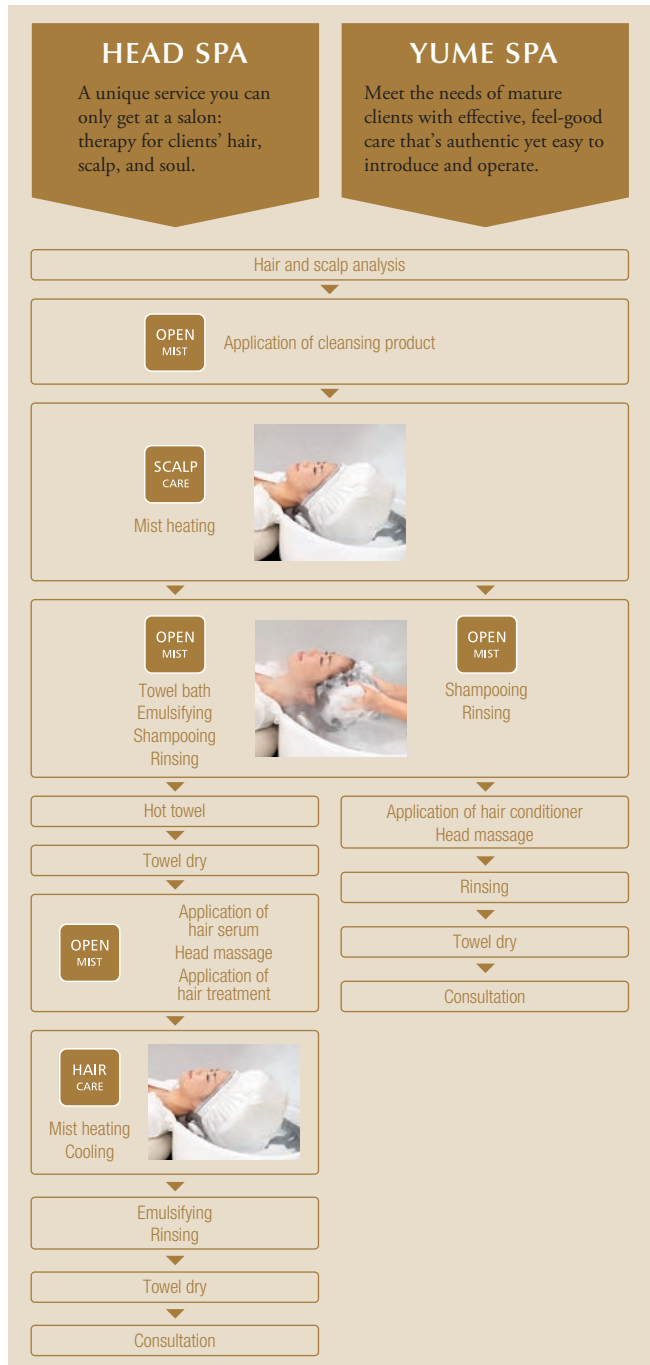

Thorough beauty treatment, greater relaxation

The professional Head Spa requires three elements: Exacting technique and effectiveness, comfortable equipment, and client rapport. By giving your salon Spa Mist II and a hair and scalp analysis system, along with the Yume shampoo chair, you can offer clients the entire spectrum of meaningful services.



Spa mist II



Professional Head Spa



Yume Espoir

Features & Variations

Function

Control Panel

Mode Selection Keys

Simply press a key to select the mode you want, and the Spa Mist II gives just the right temperature and amount of mist required for the treatment.

Level Setting Keys

Adjust the length of time, as well as the temperature and quantity of mist, required to match the hair and scalp conditions and the hair cosmetics used.

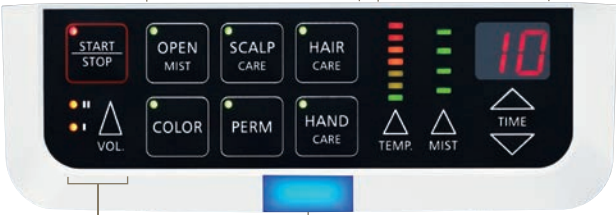

Volume Key

Choose one of three levels (Large, Small, Mute) for the volume that is right for the treatment.

Status Indicator

The indicator lights up or blinks to alert the user of the operation status.

Part Names



- Flexible Hose**
- Detachable Tray**
For temporarily placing caps, turbans, and other items.
- Water Supply Container**
Fits unobtrusively on the main unit.
- Drain Tank**
- Hose Holder**
- Power Switch**
- Drain Stopper**
- Cord Hook**
- Stand Base**
An optional storage basket can be placed on the stand base.

Design & Colors

Stand type



850 mm

White

AK-160SW/ay-160S

Brown

AK-160SBR/ay-160S

Black

AK-160SB/ay-160S

Trolley type

Convenient for use in less roomy salons.

EA-160WB (Trolley: Black)
EA-160WS (Trolley: Silver)



Options





Open Mist Ball Nozzle
Just attach it to the shampoo basin for easy Open Mist treatment.



Aromatherapy Diffuser Holder
Attach to the Open Mist Ball Nozzle to combine mist with a soothing aroma that enhances the client's relaxation.

Accessories (Included with Main Unit)

Name	Photo	Description	Code
Deionizer		<ul style="list-style-type: none"> Housing Cartridge Hardness tester 	EX-TJ5
Flexible Hose		1 unit (350 to 680 mm)	
End Cap/ Coupling		2 sets	

Note: When the deionizer cartridge reaches its capacity and becomes exhausted, pure water will not be produced, which could cause equipment to malfunction. Check the water using the hardness tester, and replace the cartridge at regular intervals.

- Cartridge only: Code BM03416
- Hardness tester only: Code BM03419

Options (Sold Separately)

Name	Photo	Description	Code
Open Mist Ball Nozzle		<ul style="list-style-type: none"> Nozzle with adhesive disk Extra adhesive disk Coupling tube x 2 	EA-160BN
Aromatherapy Diffuser Holder		<ul style="list-style-type: none"> Holder for diffuser pad Aromatherapy diffuser pad x 5 <p>Notes:</p> <ul style="list-style-type: none"> Aromatherapy oil is not supplied. Must be used with Open Mist Ball Nozzle. 	EA-160AH
Flexible Hose Holder		<p>1 unit (400 mm)</p> <ul style="list-style-type: none"> Holds the flexible hose. Used for Head Spa, treatments, coloring, and perming in a styling chair or men's chair. 	EA-160HH
Turban		<p>3 pieces</p> <p>Note: Improves adhesion at face line when using caps.</p>	EA-200N1T
Treatment Cap (white)		• For use with Yume and Open Mist Ball Nozzle x 2	EA-CMC-YB
		• For use with Rear Shampoo or Yume x 2	EA-SMC-RSW
		• For use with styling chair x 2	EA-SMC-SW
		• For use with Calme or men's chair x 2	EA-SMC-CA
Perming Cap, Coloring Cap (silver)		• Large (for perming) x 1, Small (for coloring) x 1	EA-SMC-PC
		Note: Small is same size as Treatment Cap.	
		• Large (for perming) x 2	EA-SMC-PCB
Storage Basket		• Small (for coloring) x 2	EA-SMC-PCS
		Note: Small is same size as Treatment Cap.	
Storage Basket		<p>1 piece</p> <p>(W 215 x D 195 x H 135 mm)</p> <p>Note: To be placed on the stand base; for storing small items.</p>	EA-160BK
Hand Care Cap CAPO		<p>1 piece</p> <ul style="list-style-type: none"> Transparent plastic cap for hand care. 	EA-160HCCP

Dimensional Drawings (Unit: mm)

Spa Mist II

- Stand type

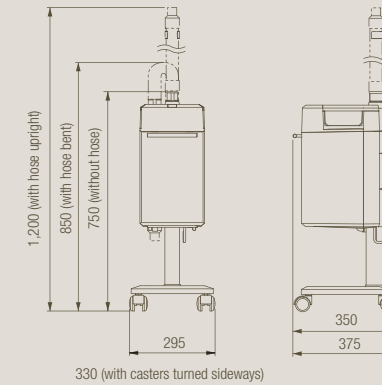

- Trolley type

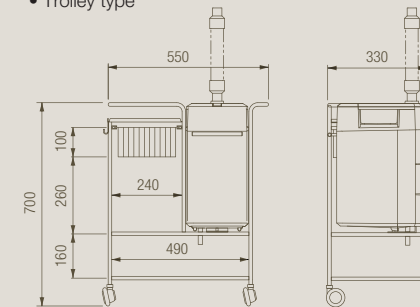

Caps

- Large (silver, for perming)
- Small (white, for treatments; silver, for coloring)



Specifications

Rated Voltage	110/120/220/230/240 V
Rated Frequency	50/60 Hz
Rated Power Consumption	490 W
Water Supply Container Capacity	1,400 ml
Drain Tank Capacity	450 ml
Weight	15.2 kg (Stand type) 23.0 kg (Trolley type)

The actual colors may differ from printed colors represented in the catalog. Design and specifications are subject to change without prior notice.



 **TAKARA BELMONT**

Telephone: +81-6-6212-3523 E-mail: beauty@takara-net.com <http://www.takarabelmont.co.jp>

B-022 Printed in Japan 2015.11